

# DATA CENTER TECHNOLOGY SOLUTIONS



## ACCESS & CONTROL

KVM Switches  
Serial Consoles  
Extenders

## POWER

Intelligent PDUs  
Rack Sensors  
Transfer Switches  
Inline Meters

**Raritan**<sup>®</sup>  
A brand of **legrand**



## WE'RE ALL ABOUT INNOVATION

The Raritan brand is synonymous with innovation in power management solutions, serial consoles, and KVM-over-IP switching technology.

In over 76 countries worldwide, Raritan's award-winning solutions increase energy efficiency, improve reliability, and raise productivity.

Visit [www.raritan.eu](http://www.raritan.eu) or call +31 (0)10 284 40 40.

# TABLE OF CONTENTS

|   |    |
|---|----|
| PROFILE                                   | 04 |
| HISTORY OF INNOVATION                     | 05 |
| POWER MANAGEMENT                          | 06 |
| INTELLIGENT PDUS                          | 08 |
| INLINE METERS                             | 09 |
| BRANCH CIRCUIT MONITORS                   | 10 |
| TRANSFER SWITCHES                         | 11 |
| DOOR HANDLES                              | 12 |
| ENVIRONMENTAL CONTROLLERS                 | 13 |
| ENVIRONMENTAL SENSORS                     | 13 |
| POWER & ENVIRONMENTAL MONITORING SOFTWARE | 14 |
| POWER PRODUCT OVERVIEW                    | 15 |
| ACCESS MANAGEMENT                         | 16 |
| KVM-OVER-IP SWITCHES                      | 18 |
| CENTRALIZED DATA CENTER MANAGEMENT        | 20 |
| ANALOG KVM SWITCHES                       | 21 |
| SERIAL CONSOLES                           | 22 |
| KVM & SERIAL PRODUCT OVERVIEW             | 23 |
| CUSTOMER EXPERIENCES                      | 26 |



# PROFILE



A proven innovator of power management solutions, serial consoles, and KVM-over-IP switching technology for data centers of all sizes.

In over 60,000 locations worldwide, Raritan's award-winning solutions increase energy efficiency, improve reliability, and raise productivity.

Raritan was founded in 1985 in Somerset, NJ (USA) and acquired by Legrand in 2015.

## GLOBAL

Raritan is represented in 76 countries with a partner network spanning the globe.

Users can rely on best-in-class hardware and software solutions supported by a team of highly skilled individuals, passionate to answer and resolve your technical product related questions.

VADs, VARs and System Integrators interested in selling Raritan products should contact [marketing.europe@raritan.com](mailto:marketing.europe@raritan.com).

When partnering with us, you'll build a stream of revenue from an array of satisfied customers. In short, we help you to grow your business by solving your client's biggest data center management challenges.



## INNOVATION

Our solutions help IT professionals gain more insight into data center operations and manage smarter in more than one way. We help maximize uptime, optimize efficiency and allow for strategic decision-making based on reliable data points.

Raritan is always looking to push technology further and innovation is at our core. With 47 patents granted and 30 more applications pending, we make sure you always have the latest and future-proof technology.

## TRUSTED

When you buy a Raritan product you can be sure you are getting a product that's been manufactured with great care and to the highest standard.

## CUSTOMER FOCUSED

At Raritan we believe customers should always come first, whether it's in designing a new product or when we get a support question, Raritan makes sure the customer gets an effortless experience.



### ENDORSER OF THE EU CODE OF CONDUCT ON DATA CENTRE ENERGY EFFICIENCY

Formulated by the EU's Joint Research Centre, the Code is a measured response to the energy challenges the EU faces. It's aim is to encourage companies with data centers to reduce energy consumption while ensuring business objectives continue to be met.

As an endorser, Raritan have pledged to implement the Code's ethos through devising products and services that help organizations to bring their data centers into line with its best practice recommendations.

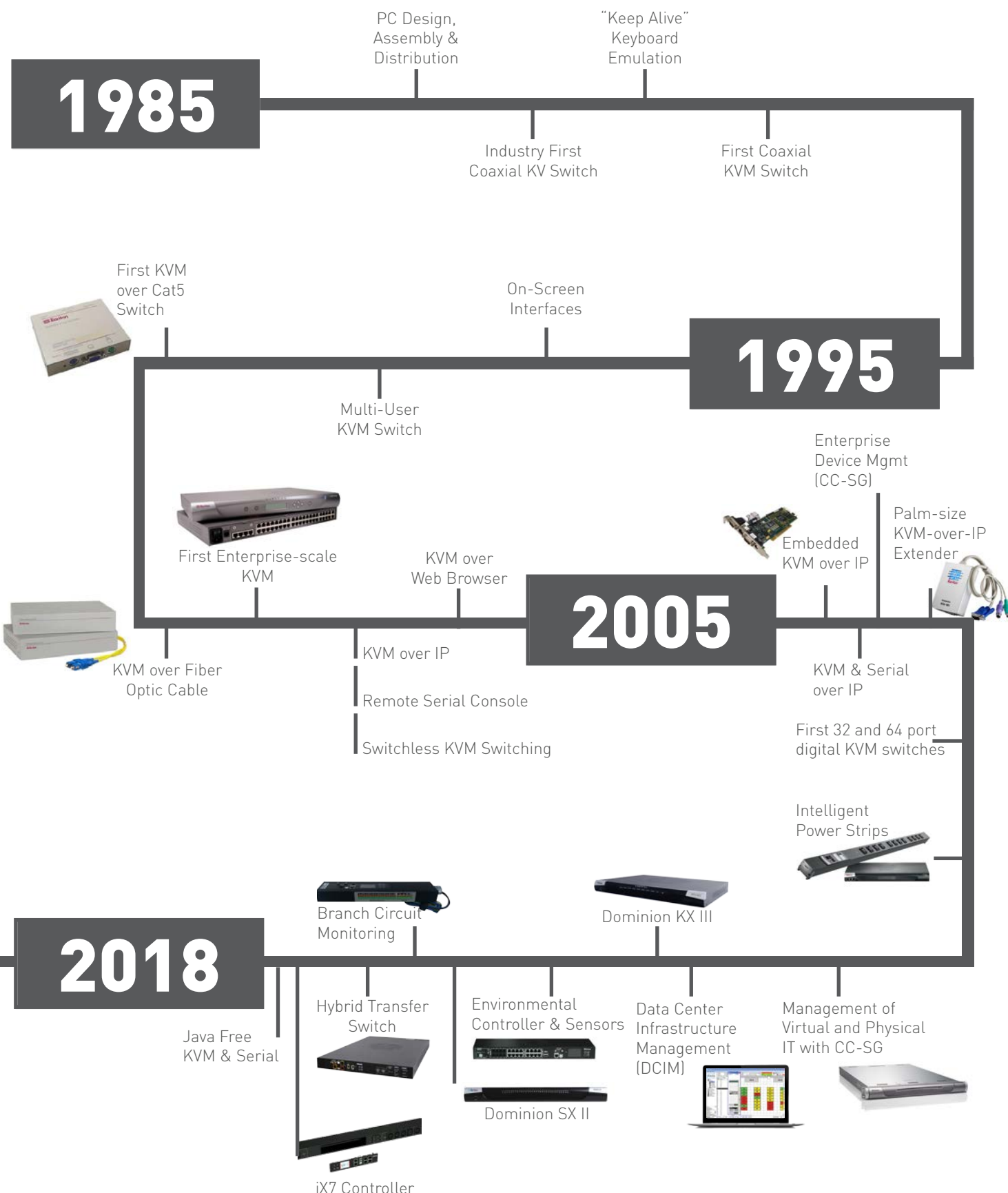

# Power Ma

**“RARITAN PROVIDES  
CUSTOMERS THE  
BEST SOLUTION FOR  
THEIR CHALLENGES,,**



# Management

## 1 POWER MANAGEMENT, MONITORING AND CONTROL

|                           |     |
|---------------------------|-----|
| INTELLIGENT PDUs          | P08 |
| INLINE METERS             | P09 |
| BRANCH CIRCUIT MONITORS   | P10 |
| TRANSFER SWITCHES         | P11 |
| DOOR HANDLES              | P12 |
| ENVIRONMENTAL CONTROLLERS | P13 |
| POWER MANAGEMENT SOFTWARE | P14 |
| PRODUCT OVERVIEW          | P15 |



# POWER MANAGEMENT

# PX<sup>®</sup> - INTELLIGENT PDUS

The Raritan PX family of high-quality, intelligent rack power distribution units (iPDUs) offers real-time remote power monitoring of current (Amps), voltage (Volts), power (kVA, kW) and energy consumption (kWh) with +/- 1% billing-grade accuracy, even at the outlet level.

The PX series offers hundreds of models to meet all your data center applications, including models with remote outlet switching, individual outlet metering, high-power for blade servers and high-density applications, and 400V power distribution.

Available in 800+ single and three phase models.



## INTELLIGENT FIELD REPLACEABLE CONTROLLER

Our flush mount controller offers industrial-grade reliability, configurable firmware, disaster recovery support, and hot swap capability in the event of a malfunction.

## DUAL NETWORK ACCESS

Equipped with two Ethernet ports, PDUs with iX7 controllers can be accessed on two separate networks. Infrastructure managers, co-location facility staff, or IT administrators can all see the same critical energy and environmental data provided by your PX, even if they're on different networks or VLANs.

## FULL COLOR CHASSIS

Raritan's intelligent PDUs are available in multiple colors that help reduce errors, and make it easier to identify power feeds, and troubleshoot, thereby lowering the risk and duration of unplanned downtime.

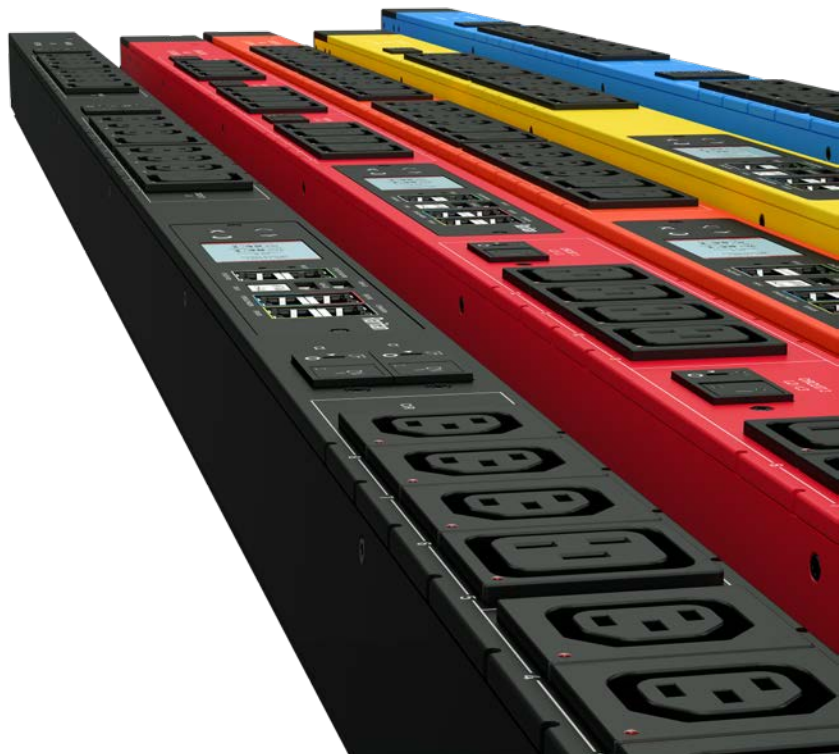



## SECURELOCK™ POWER CORDS

IEC outlets often fail to securely hold plug due to vibration or human error. Raritan's intelligent rack PDUs are equipped with SecureLock outlets that lock when using SecureLock power cords to prevent accidental disconnects.



## BUILT-IN FAILOVER POWER

Using the expansion port available on some PX models, maintain network connectivity and power between two connected PDUs. Outage alerts lead to faster remediation, allowing you to maintain full control over the peripherals connected to your PDU and devices cascaded downstream.

## RESIDUAL CURRENT MONITORING OPTION

By measuring current flowing in the ground wire, the residual current monitoring option reduces the risk of electric shock. Residual currents generate a system alert, keeping technicians safe. By providing automated and remote testing, PDUs equipped with residual current monitoring dramatically reduce the burden of regulatory auditing in many jurisdictions.

For further information, see [www.findmypdu.com](http://www.findmypdu.com)

|         | SWITCHING | OUTLET METERING | INLET METERING | CIRCUIT BREAKER METERING |
|---------|-----------|-----------------|----------------|--------------------------|
| PX-1000 |           |                 | ■              | ■                        |
| PX-2000 | ■         |                 | ■              | ■                        |
| PX-4000 |           | ■               | ■              | ■                        |
| PX-5000 | ■         | ■               | ■              | ■                        |

## INLINE METERS

The PX-3000 Series Inline Power Meters simplify management of power usage and environmental conditions in the data center while allowing you to monitor the power on dedicated circuits.

There is no need to remove or re-cable IT equipment. Just wire the inline meter into existing circuits and get real-time remote power monitoring, including current (amps), voltage (Volts), power (kVA, kW) and energy consumption (kWh) to +/- 1% accuracy. Plus they're sensor ready to support all Raritan environmental sensors.



# POWER MANAGEMENT

# BRANCH CIRCUIT MONITORS



Raritan's intelligent Branch Circuit Monitoring (BCM) system allows you to fully utilize your power infrastructure and manage capacity as your data center grows and changes. Whether you are retrofitting an existing facility, or planning for growth or new construction, Raritan's BCM system can help you reduce energy costs, track power usage, and prevent downtime. Easily add metering where it never existed before.

This easy-to-deploy modular system, enables real-time views of electrical capacity and power usage on branch circuits, and mains, in an electrical service entrance or a remote power panel. It sends threshold alerts for power and environmental conditions, thereby helping to prevent downtime. The data can also support energy efficiency and customer charge-back initiatives.

## FEATURES AND BENEFITS

- Meters Floor PDU, RPPs, Panelboards, and Busways
- One controller supports up to 70 power meters
- Current Transformers (CTs) connect to live circuits
- Auto-correct metering adjusts for CT orientation on wires
- Real-time configurator
- USB ports for configuration, Wi-Fi networking, and tablet display
- Several enclosure options
- Collects data on: A, V, kW, kVA, power factor, and kWh
- Protocols include TCP/IP, Modbus and SNMP

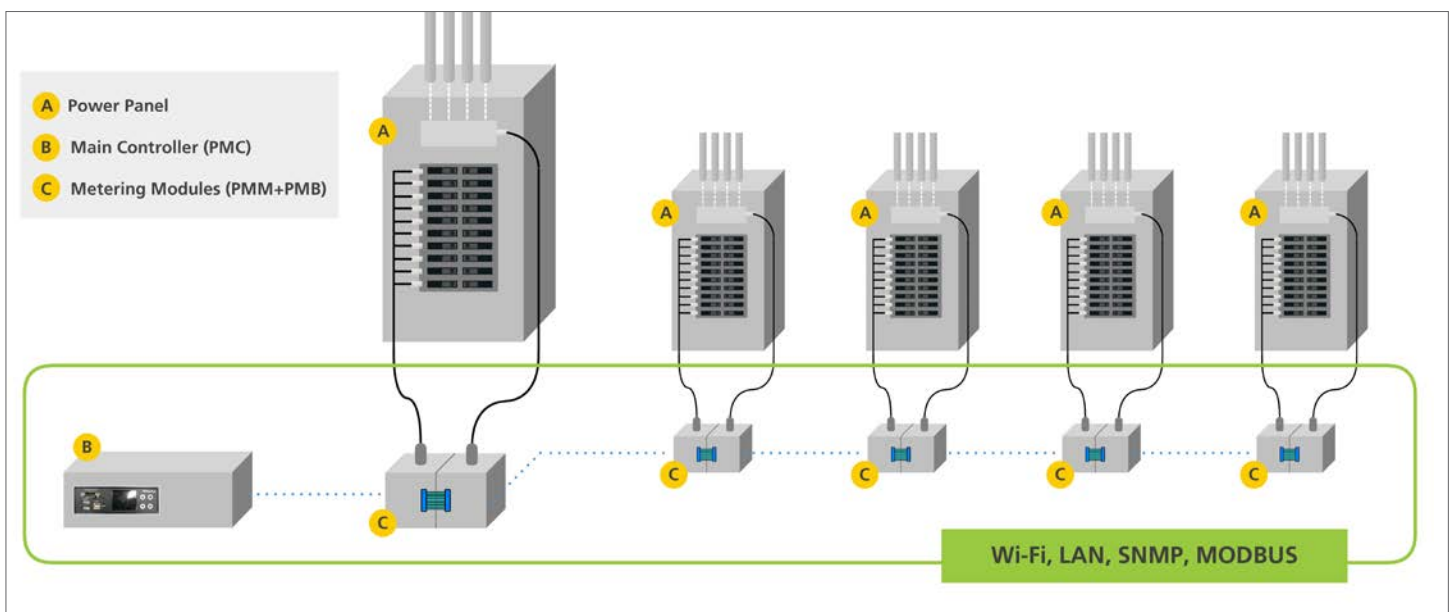

# TRANSFER SWITCHES



Raritan's hybrid rack transfer switch prevents downtime in racks with single power supply devices. It provides power metering at the inlet, outlet, and branch circuit level. It also offers outlet-level switching for better remote power control.

This switch cleverly uses both electromechanical relays and silicon-controlled rectifiers (SCRs) to maximize the positive and minimize the negative characteristics of both automatic and static transfer switches (ATS/STS).



## FEATURES AND BENEFITS

- Fast transfer: Load transfer times 4 - 8ms
- Reliable transfer between sources regardless of phase
- Over-sized relays (rated 48A) and SCRs (rated 70A)
- Eliminates electrical arcing that leads to relay failures
- 3.3mm vs. typical 0.6mm air gap to prevent arcing due to surges
- Inlet surge protection and field replaceable, fast-blow fuses for short circuit protection
- Threshold alerting and status updates via email and syslog, SNMP V1/2 and 3
- Logs transfer times for reporting
- Support for up to 32 plug-and-play sensors
- USB support i.e. Wi-Fi, camera, tablet, and cascading



# POWER MANAGEMENT

## SMARTLOCK DOOR ACCESS CONTROL



Raritan's SmartLock is an electronic door access and control system which provides an easy to deploy and economical networked locking solution for all types of data center enclosures. It is a cost-effective, universal solution that addresses evolving security requirements for IT applications and regulatory compliance from HIPAA, SOX, PCI DSS 3.2, or SSAE 16.

The SmartLock system is compatible with Raritan's PX intelligent PDUs and EMX which eliminates the need for expensive installation and a complete separate door locking system. To allow seamless crucial data delivery to DCIM and security software, the SmartLock system easily connects to the PX plug and play sensor.

### EASY TO DEPLOY / RETROFIT

- Universal lock footprint, easy to retrofit in any existing rack door
- Pre-integrated option for Legrand Mighty-Mo, LX Cabinets, and row enclosures
- Secures up to 16 cabinets (32 Locks front and rear) under a single IP address linked to the PX intelligent PDU or EMX
- Pre-configured to be recognized by PDUs for rapid deployment across your entire data center



### FEATURES AND BENEFITS

- Smart Card Compatible
- Integration with Raritan's Asset Management
- Solution for Workflow Management
- Remote Lock/Unlock
- Configurable Unlock Time Delay
- Customizable Alerting (Powered by Xerus)
- LED Status Indicator
- Event Logging
- LDAP and RADIUS Compatible
- Proximity, Tamper, and Door Position Sensors Compatible
- Integrates with Sensors for Lock Status, Monitoring, and Alarms





# ENVIRONMENTAL CONTROLLER



EMX is a central connection point for all of Raritan's environmental sensors. The EMX smart rack controller offers up to eight sensor ports, eight feature ports for Raritan's dynamic asset-tracking solution (AMS) and eight RS-485 ports, all in a 1U form factor.

This innovative rack monitoring solution helps data center and facilities managers to ensure uptime by monitoring racks for possible hot spots, save on cooling costs by confidently raising data center temperatures and make strategic decisions on environmental design & modifications.

## FEATURES AND BENEFITS

- USB Webcam Support
- Supports up to 128 sensors
- Wired or WiFi Network Ready
- Web Browser Accessible
- Receive Advanced Alerts

## ENVIRONMENTAL SENSORS



Raritan environmental solutions feature sensors for monitoring temperature, humidity, airflow, air pressure, water/leaks, contact closures, digital proximity, and acceleration.

The sensors are deployed as valuable plug-and-play options to connect to Raritan's intelligent rack PDUs, EMX controllers, inline meters, transfer switches, and branch circuit monitors.

Environment sensors make it easy to identify hot spots, cool equipment optimally, prevent downtime, and maintain facility security.

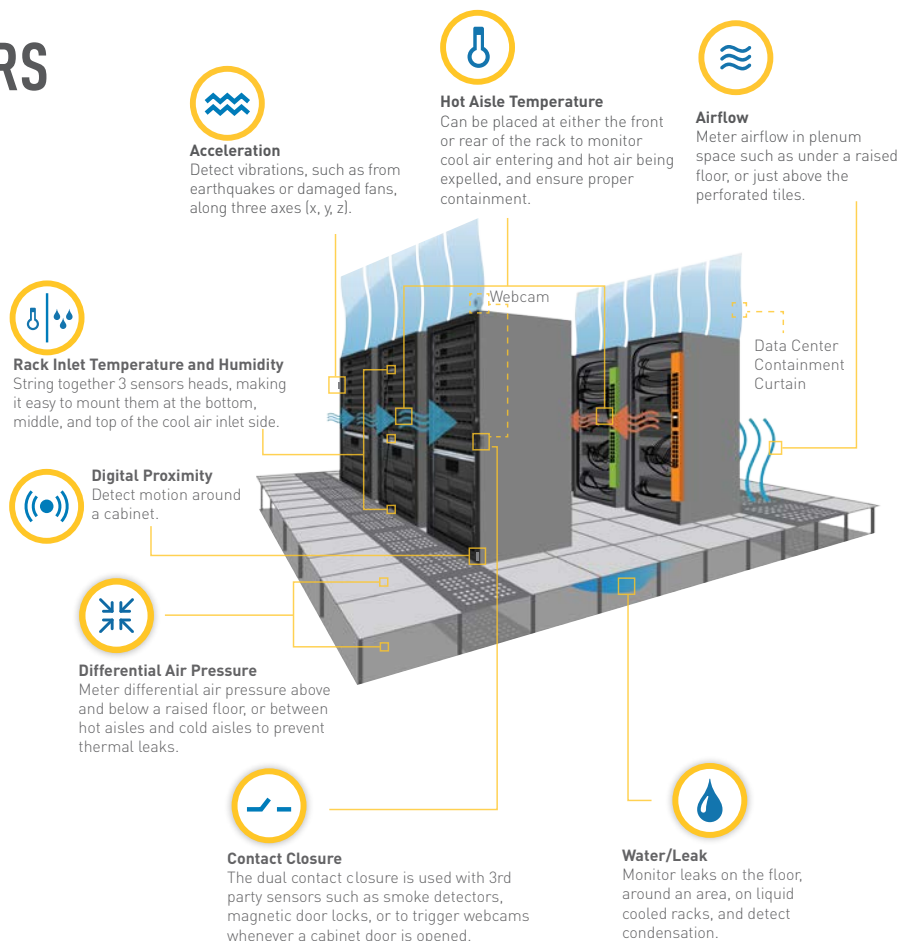

# POWER IQ®



Power IQ enables data center and facility managers to closely monitor and efficiently utilize existing data center power infrastructures. Data center health maps, power analytics, cooling charts, and reports provide the tools to alert you to potential trouble and understand real-time power load, trends, and capacity at all levels of the power infrastructure.

Environment data collected by sensors is instantly sent to Raritan's Power IQ DCIM monitoring software which allows you to confidently raise ambient temperatures and adjust fan speed in CRACs to increase your energy savings and get the most out of your cooling systems.

Power IQ, initially developed by Raritan and now offered to you by Sunbird Software Inc., fully integrates with Raritan power management products.

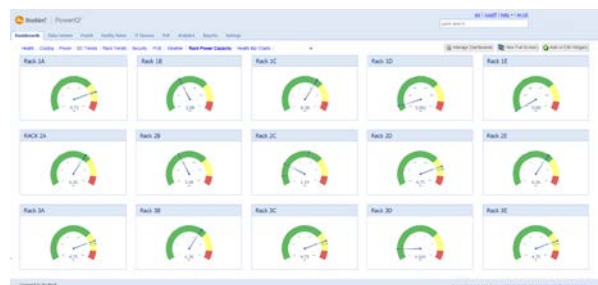
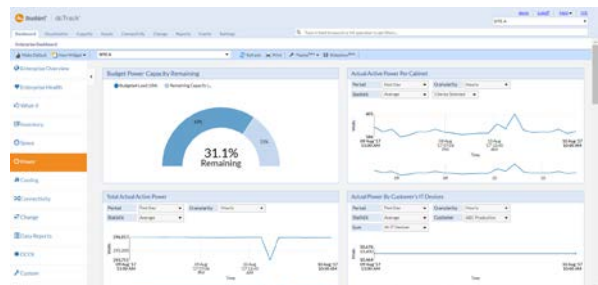

## POWER IQ ALLOWS YOU TO:

- See hot spots at-a-glance
- Know when to increase/decrease temperature set points
- Know how much to humidify
- Easily manage to ASHRAE standard thermal envelopes
- Simplify how you manage airside economization
- Customize and add your own thermal envelopes

Find out more on [sunbirddcim.com](http://sunbirddcim.com)

# POWER PRODUCT OVERVIEW

Since offering intelligent power distribution units in 2007, Raritan has now achieved a 3rd position worldwide and is still growing fast with an ever expanding portfolio of power products. Below you can find an overview of our current power management portfolio.



## INTELLIGENT PDUs

Our intelligent rack power distribution units (iPDUs) include outlet switched, outlet metered, unit metered, and more. Available in single and three phase models.



## SMART BUDGET PDUs

PXE is a family of Intelligent Rack PDU's for the budget conscious buyer looking for an entry level iPDU solution to gain more insight.



## INLINE METERS

PX-3000 Intelligent inline power meters that easily add power, energy and rack environmental data collection capabilities to stand-alone IT equipment.



## TRANSFER SWITCHES

The hybrid rack transfer switches use electromechanical relays and silicon-controlled rectifiers (SCRs) to transfer a load between two sources.



## BRANCH CIRCUIT MONITORS

The BCM series of intelligent branch circuit meters provide power and energy data on branch circuits and mains in an electrical service entrance or a remote power panel.



Security

## POWER CORDS

Prevent accidental power cord disconnects with SecureLock - an integrated locking system of power cords and rack PDU outlets which secures power cords to rack PDUs.



Security

## DOOR HANDLES

Raritan's SmartLock is an electronic door access and control system which provides an easy to deploy and economical networked locking solution for all types of data center enclosures.



Monitoring

## POWER INFRA MANAGEMENT

Power IQ powered by Sunbird Software Inc. enables data center managers to closely monitor and efficiently utilize their existing data center power infrastructure.



Environmental

## SMART RACK CONTROLLERS

The EMX smart rack controller is a central access point for all of Raritan's environmental sensors such as temperature and humidity, and in conjunction with Sunbird's data center infrastructure management solution (DCIM) provides sensor readings and asset management.



Environmental

## ENVIRONMENTAL SENSORS

Environment sensors such as temperature, humidity, airflow, air pressure, water, and contact closure help data center managers identify hot spots, efficiently and optimally cool equipment, prevent costly downtime, and maintain data center security.

# Access Ma

“TECHNOLOGY BORN  
OUT OF PASSION.”





# management

## 2 | ACCESS MANAGEMENT, PERFORMANCE AND SECURITY

|                                    |     |
|------------------------------------|-----|
| KVM-OVER-IP SWITCHES               | P18 |
| COMPUTER INTERFACE MODULES         | P19 |
| CENTRALIZED DATA CENTER MANAGEMENT | P20 |
| ANALOG KVM SWITCHES                | P21 |
| SERIAL CONSOLES                    | P22 |
| PRODUCT OVERVIEW                   | P23 |



# ACCESS MANAGEMENT

# ENTERPRISE KVM-OVER-IP (KX III)

The Dominion KX III is Raritan's flagship enterprise-class KVM-over IP switch. With industry leading video performance, security, and enhanced reliability, the Dominion KX III outperforms the competition. With standard features such as DVI /HDMI / DisplayPort digital video, VGA analog video, audio, virtual media, smart card/CAC, and mobile access, the Dominion KX III is suitable for both general computer and dynamic broadcast applications.

It's ideal for Server Rooms, Test Labs, and the largest Enterprise Data Centers. KX III offers high performance web-based remote management of servers, storage, and network devices and virtually any application. Deploy individually, or centralize with Raritan's CommandCenter Secure Gateway (see page 20).



The Dominion Serial Access Modules (DSAM) allow users to connect serial devices with Java-free user access from the Dominion KX III.



## AMAZING DIGITAL VIDEO & AUDIO PERFORMANCE

30 frames-per-second, high definition video support over-IP. The 1920x1200, high definition, digital video performance supports broadcast and other dynamic, video-intensive applications. A DVI digital local port provides fast, at-the-rack access.

## MOUSE IN SYNC

Raritan KVM switches come with the unique Absolute Mouse Synchronization™. It provides perfect mouse synchronization without changing server mouse setting.

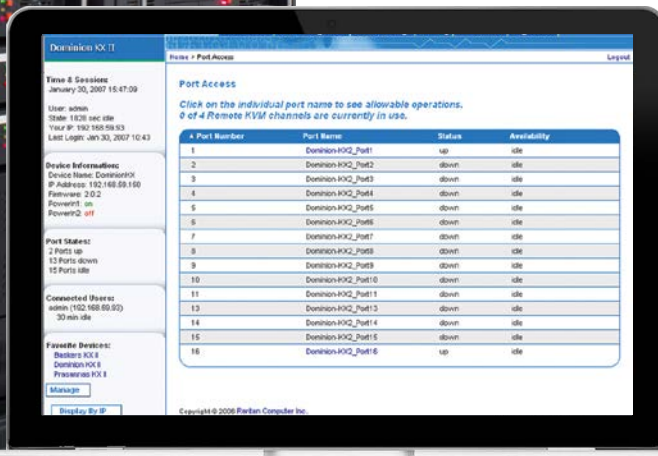

Time & Session: January 30, 2007 15:47:09  
User: admin  
State: 1828 sec idle  
Year IP: 192.168.80.93  
Last Login: Jan 30, 2007 10:43

Device Information:  
Device Name: DominionKX  
IP Address: 192.168.80.150  
Firmware: 2.0.2  
PowerM: on  
PowerM2: off

Port Status:  
2 Ports up  
13 Ports down  
15 Ports idle

Connected Users:  
admin (192.168.80.93)  
30 min idle

Favorite Devices:  
Dominion KX III  
Dominion KX III  
Proximate KX III

Message

Logout, By IP

Port Access

Click on the individual port name to see allowable operations.  
0 of 4 Remote KVM channels are currently in use.

| Port Number | Port Name           | Status | Availability |
|-------------|---------------------|--------|--------------|
| 1           | Dominion_KX2_Port1  | up     | idle         |
| 2           | Dominion_KX2_Port2  | down   | idle         |
| 3           | Dominion_KX2_Port3  | down   | idle         |
| 4           | Dominion_KX2_Port4  | down   | idle         |
| 5           | Dominion_KX2_Port5  | down   | idle         |
| 6           | Dominion_KX2_Port6  | down   | idle         |
| 7           | Dominion_KX2_Port7  | down   | idle         |
| 8           | Dominion_KX2_Port8  | down   | idle         |
| 9           | Dominion_KX2_Port9  | down   | idle         |
| 10          | Dominion_KX2_Port10 | down   | idle         |
| 11          | Dominion_KX2_Port11 | down   | idle         |
| 12          | Dominion_KX2_Port12 | down   | idle         |
| 14          | Dominion_KX2_Port14 | down   | idle         |
| 15          | Dominion_KX2_Port15 | down   | idle         |
| 16          | Dominion_KX2_Port16 | up     | idle         |

Copyright © 2006 Raritan Computer Inc.

**DOMINION® KX III USER STATION**

Standalone appliance for high performance IP access to servers connected to Dominion® KX III switches. Deploy it using standard Cat5 cabling and Ethernet/IP technology. It's perfect for broadcast, labs, studios, control rooms, offices, and data centers.



**ACCESS & CONTROL  
REMOTE BIOS-LEVEL**

Dominion KX III has the industry's highest performing and most flexible KVM-over-IP technology. Users can access Dominion KX III from LAN, WAN, Internet, mobile & dial-up, allowing admins BIOS-level access to troubleshoot, reconfigure, reboot and power cycle servers remotely.

**VIRTUAL MEDIA OVER IP**

Each Dominion KX III comes equipped with virtual media to enable remote tasks, such as software installation, remote booting and diagnostics, using the widest variety of media storage (CD, DVD, USB, internal and remote drives, and images).

**MILITARY GRADE SECURITY**

With Raritan's Dominion KX III, you can meet government and military security mandates, including: AES & FIPS 140-2 encryption, Common Access Card (CAC) authentication, and IPv6 networking.

**ELIMINATE JAVA USE**

You can finally say so long to Java on Windows Platforms with the Active KVM Client (AKC). Enjoy Java-free KXIII administration on all platforms.

“**SERIAL AND KVM-OVER-IP  
ACCESS FROM A SINGLE SWITCH**”



**COMPUTER INTERFACE MODULES (CIMS)**

Raritan offers a full line of CIMS to support a variety of platforms and applications.

A suite of multiplatform CIMS to connect to VGA, DVI, HDMI and DisplayPort, USB with virtual media, Sun®, Sun USB and serially controlled servers, as well as popular blade server models from: HP®, IBM®, Dell® and Cisco®.





# ACCESS MANAGEMENT

# CENTRALIZED MANAGEMENT (CC-SG)



Raritan's CommandCenter Secure Gateway (CC-SG) provides IT and lab organizations with secure and consolidated access and power control of all technology platforms at the application, operating system or BIOS level.

CC-SG's single pane of glass helps simplify remote management and expedite troubleshooting of physical and virtual servers, intelligent PDUs, and serial devices.

Available as hardware, VMware or Hyper-V appliances.



## FEATURES AND BENEFITS

- Single point of access to physical servers (including blade systems and PCs), virtual machines and VMware® infrastructures
- Flexible client options for convenient server access and management of servers and PDUs from an iPhone or iPad
- Centralized authentication, authorization and logging
- Intuitive menus and easy reporting - everything from usage and auditing to assets and nodes
- Centralized, role-based, user access policy management
- Robust security features
- High availability and redundancy

### Out-of-Band KVM and Serial Access



**Dominion® Solutions**  
 - KX III, KSX II, KX2-101-V2 and SX II  
 - Rack Mounted and Blade Servers  
 - Network Devices  
 - PX Intelligent PDU

### Remote Power Control



**Power IQ Integration**  
 - Outlet-Level Control via Raritan and Third-Party PDUs

### Virtual Machines



**VMware**



**CommandCenter Secure Gateway**  
 Secure, Centralized Data Center Management

### In-Band Data Center Access Solutions



- |                |                           |
|----------------|---------------------------|
| <b>IP Tool</b> | <b>Service Processors</b> |
| - RDP          | - iLO/iLO2                |
| - VNC          | - DRAC                    |
| - SSH          | - RSA                     |
| - Telnet       | - IPMI                    |
| - Web Browser  | - IMM                     |



# MASTERCONSOLE DIGITAL



Employing state-of-the-art technologies in a compact device, Raritan's MasterConsole Digital KVM switch (MCD) and 17" LED Console Drawer with integrated KVM switch (MCD-LED) provides reliability, ease of use, and convenience that you need in your data center, lab or server room.

The MCD supports the highest HD video resolution of up to 1920 x 1080 via standard Category 5/6/6e. The digital video interface supports both Analog — VGA and Digital — DVI, HDMI and DisplayPort. Stereo audio is also supported by using VGA combo cables or Raritan's HDMI CIMs.

Building upon Raritan's history of success with KVM switches, the MasterConsole Digital Series is ideal for performing system maintenance, administration, running applications, and troubleshooting.

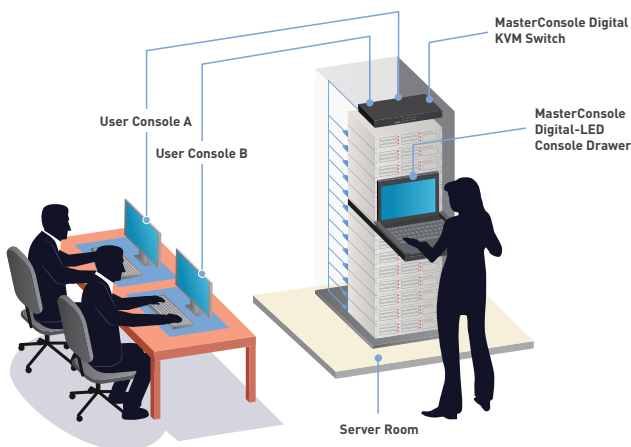

## FEATURES AND BENEFITS

- Single or dual user to control 8, 16 or 32 servers
- Control up to 1024 servers by cascading
- Support VGA/DVI/HDMI/DP digital video interfaces
- High resolution video — 1920 x 1200 @75Hz (Analog) & 1920 x 1080 (Digital)
- Secure password authentication

### MCD-LED

- 1U, small form factor design
- Single user of control 8 or 16 servers
- Control up to 512 servers by cascading
- Support VGA/DVI/HDMI/DP digital video interfaces
- Widescreen resolution support up to 1920 x 1080

### MCD-232



### MCD-LED17116

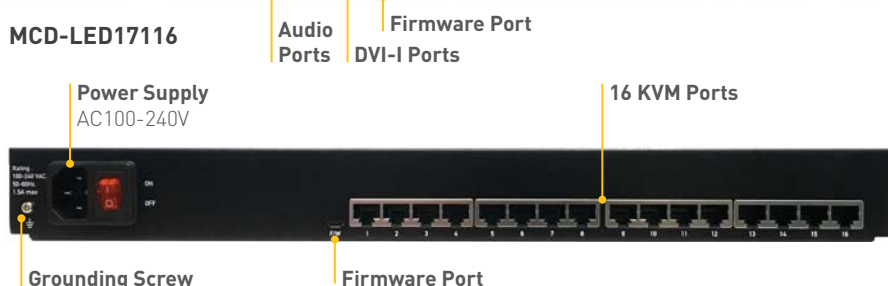

# ACCESS MANAGEMENT

# SERIAL CONSOLE (SX II)

The Dominion SX II is Raritan's next-generation Serial Console Server (Terminal Server) that provides IT and network administrators secure IP access and control of serial devices, anytime, anywhere. The new SX II is the most powerful, secure, reliable, easy-to-use serial-over-IP device on the market. SX II provides convenient access to networking devices, servers, PDUs, telecommunications and other serial devices.

## POWERFUL HARDWARE PLATFORM FOR HIGH PERFORMANCE SERIAL ACCESS

- Powerful 1GHz CPU engine
- Flash memory, up to 8 GB, for storage and logging
- Dual power supplies and dual gigabit Ethernet LAN ports, with automatic failover
- 4, 8, 16, 32 and 48 port 1U secure appliances (optional telephone modem)

## SERIAL-OVER-IP ACCESS

Complete CLI access and management via SSH, Telnet and web-browser, with convenient direct port access methods. Two script-based automatic configuration methods (TFTP server and USB stick) are available for fast installation and configuration changes. Scales to thousands of devices with Raritan's CommandCenter Secure Gateway.

## BROAD SERIAL DEVICE SUPPORT

Enjoy comprehensive serial device access to a wide range of equipment. Support for operating speeds of 1,200 to 230,400 bps with flexible, per-port serial options.



## FULL CLI-BASED CONFIGURATION AND AUTO-CONFIGURATION

The SX II offers complete CLI access and management via SSH, Telnet and web-browser, with convenient direct port access methods. Two script-based automatic configuration methods (TFTP server and USB stick) are available for fast installation and configuration changes. Automatic port naming based on hostname.

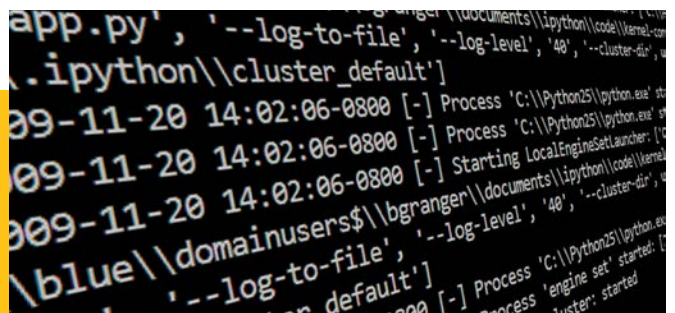

DOMINION SX II OFFERS MULTIPLE FORMS OF SERIAL-OVER-IP ACCESS

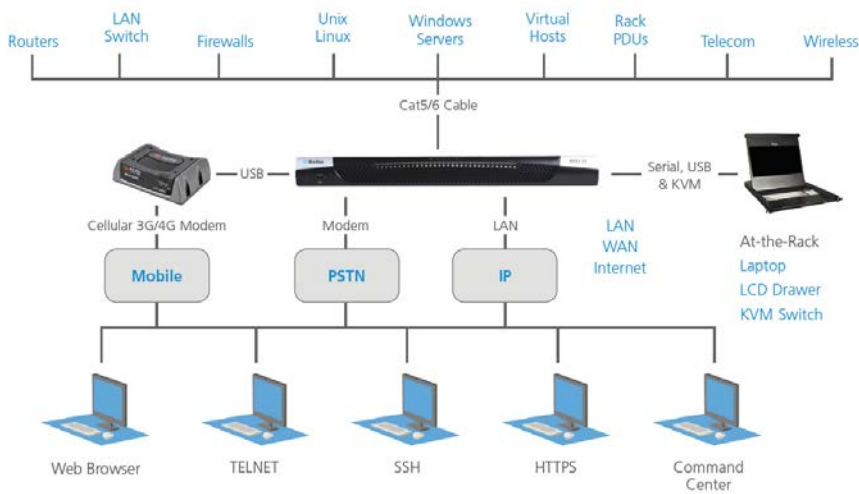

**SECURE IP ACCESS  
MILITARY GRADE SECURITY**

Achieve military-grade security levels, including: strong AES and certified FIPS 140-2 encryption, LDAP/RADIUS/Active Directory authentication, and dual stack IPv4 and IPv6 networking.

**AUTOMATIC DTE/DCE SERIAL  
PORT DETECTION**

For fast installations, the SX II supports straight Cat5 connections to Cisco and other compatible RJ-45 devices, without rollover cables. The SX II can also directly replace the first generation SX with compatible serial device connections.

**3G/4G MODEM ACCESS**

The SX II offers an optional internal telephone modem and can connect to an external cellular (3G/4G) modem for emergency access.

For further information,  
see [www.raritan.com/sx-ii](http://www.raritan.com/sx-ii)

“**JAVA-FREE SERIAL-OVER-IP  
ACCESS TO ENHANCE YOUR  
PRODUCTIVITY**”

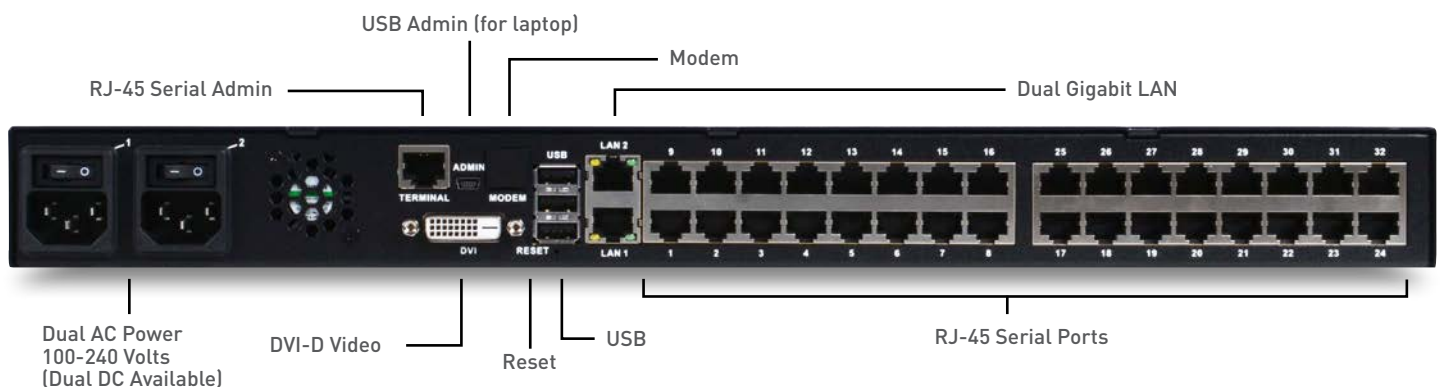

# KVM & SERIAL PRODUCT OVERVIEW

For over 30 years Raritan has been at the forefront of developing cutting edge technology. From enterprise solutions to small businesses Raritan's KVM solutions are unmatched in quality and durability. Below you can find our current KVM portfolio.



## COMMANDCENTER® SG

An easy to deploy, plug-and-play appliance that provides a single pane of glass access to all servers, storage, and network equipment.



## DOMINION® KX III

Enterprise-class, secure KVM-over-IP switch that provides BIOS-level remote management of up to 64 multi-platform servers and serial-based devices in a single switch.



## DOMINION® KX III USER STATION

Standalone appliance for high performance IP access to servers connected to KX III switches.



## DOMINION SERIAL ACCESS MODULES (DSAM)

DSAM allows users to connect serial devices with Java-free user access from the Dominion KX III.



## DOMINION® KX II-101 V2

Palm-sized, single port KVM-over-IP for web-based remote management of a single server or a KVM-over-IP extender for an analog KVM switch.



## DOMINION® LX

High quality BIOS-level, KVM-over-IP remote management for 1 or 2 users, 8 or 16 ports and up to 256 servers with tiering.



## DOMINION® SX II

Serial console server provides admins secure remote access, monitoring, and control all of their serial devices.



## DOMINION® KSX II

Solution for branch/remote offices and retail stores and racks with both serial and KVM-managed devices.



## CAT5 REACH® DVI

Provides 1080p HD video quality while enabling extended remote access to DVI and VGA ports on PCs, servers, AV devices or KVM switches.



## MASTERCONSOLE DIGITAL

Next generation of Cat5 KVM switches for SMB IT environments. It is ideal for performing system maintenance, administration, and troubleshooting.





**DISCOVER HOW RARITAN CAN  
HELP YOU ADD INTELLIGENCE  
TO YOUR DATA CENTER.**

**START REDUCING COSTS AND  
IMPROVE EFFICIENCY,  
UPTIME AND CAPACITY  
PLANNING.**

# CUSTOMER EXPERIENCES



Soaring energy prices, greater competition in the marketplace, and global concerns over climate change are forcing companies to reconsider how they utilize power in the most valuable and energy intensive resource they own – the data center. It's why data centers are now so focused on cutting operational costs by improving efficiencies, and making optimal use of energy, space, and cooling.

Not surprisingly, many of the major strategies being employed to address these challenges depend on capabilities that were not present in the simple commodity power strips of a few years ago.

## REAL-TIME ENERGY OPTIMIZATION AND BEST PRACTICES IN A MISSION-CRITICAL DATA CENTER

### CUSTOMER

Founded in 1995, eBay connects a diverse and passionate community of individual buyers and sellers, as well as small businesses. With more than 90 million active users globally, eBay is the world's largest online marketplace, where practically anyone can buy and sell practically anything.

### CHALLENGES

With compute loads – and operating costs – on the rise, eBay created and began executing a four-year data center plan with an ambitious goal:

- To cut power costs in half
- To double compute performance
- To gain greater operational agility and increased reliability

### SOLUTIONS

Power Management  
PX intelligent PDUs

**“PX INTELLIGENT PDUs CAN PROVIDE ME WITH THE PRECISION REQUIRED TO CALCULATE MY TRUE OPERATIONAL COSTS FOR EVERY SERVER, DOWN TO THE LAST PENNY,,**

### RESULTS

eBay developed a model for its data centers that makes their IT operations both highly reliable and 50% less expensive to operate than the data centers they are decommissioning. In addition to minimizing faults and lowering operating costs, eBay's South Jordan, Utah facility has achieved the U.S. Green Building Council's Leadership in Energy & Environmental Design (LEED) Gold ranking. Just as important as the LEED Gold efficiency ranking and Tier IV reliability is the flexibility designed into the eBay data center.



EPAM Systems is one of the largest developers of (custom) project software and one of the leading players in the field of IT consulting in central and eastern Europe. The company, founded in 1993, employs more than 5,500 specialists and implements projects in more than 30 countries. Company branch offices are located in Russia, Ukraine, Belarus, Kazakhstan, the United States, Hungary, the United Kingdom, Germany, Sweden and Switzerland.

## PROFESSIONAL SOLUTION FOR IT PROFESSIONALS

### CUSTOMER

EPAM Systems' primary business activities include: software development, testing, maintenance and support of custom software and business applications; the creation of dedicated software development centers (competence centers), as well as IT consulting.

### CHALLENGES

The largest service provider in the field of software development needed to ensure prompt, secure and reliable access to servers in the data center with the ability to remotely install software from connected drives and media while users are sitting at their desks.

### SOLUTIONS

Dominion® KX KVM-over-IP switches with virtual media support, security and redundancy features.

**“RARITAN PROVIDED US WITH DEMO ACCESS TO SERVERS CONNECTED TO THEIR KVM-OVER-IP SWITCH WHICH FULLY SATISFIED US,,**

### RESULTS

The EPAM Systems IT department has significantly increased productivity and reduced downtime of their servers. Reducing the number of cables in their data center racks has helped to improve air circulation within the data center.





# Raritan®

A brand of  legrand

## EUROPEAN HEADQUARTERS

Jan van Galenstraat 59  
3115 JG Schiedam - The Netherlands

Phone: +31 (0)10 284 4040  
Email: [sales.europe@raritan.com](mailto:sales.europe@raritan.com)

## RARITAN FRANCE

19, boulevard Georges Bidault – B2  
77183 Croissy-Beaubourg - France

Phone: +33 (0)1 64 61 61 91  
Email: [sales.france@raritan.com](mailto:sales.france@raritan.com)

## RARITAN UNITED KINGDOM

4th Floor, 25-26 Lime Street  
London, EC3M 7HR - United Kingdom

Phone: +44 (0)20 7090 1390  
Email: [sales.uk@raritan.com](mailto:sales.uk@raritan.com)

## RARITAN GERMANY

Kaistraße 18  
40221 Düsseldorf - Germany

Phone: +49 (0)375 / 271 349 47-99  
Email: [sales.germany@raritan.com](mailto:sales.germany@raritan.com)